

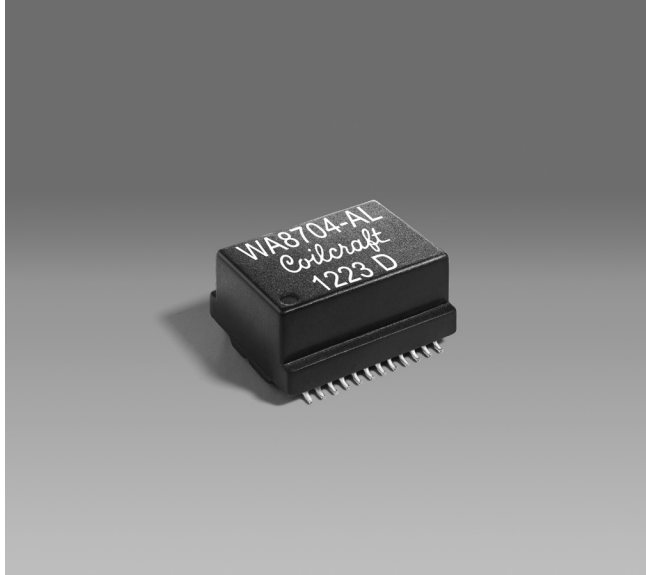

PoE Signal Path Transformer WA8704-AL



- Designed to meet upcoming IEEE802.3bt high power PoE standard
- Designed for 150 W 4-pair signal path with 1.5 A on each center tap*
- Exceeds return loss requirements of Gbit Ethernet
- 1500 Vrms, one minute isolation (hipot) winding to winding

Core material Ferrite

Terminations RoHS compliant tin-silver-copper over tin over nickel over phos bronze

Weight 3.6 g

Ambient temperature -40°C to +85°C

Storage temperature Component: -40°C to +85°C.

Tape and reel packaging: -40°C to +80°C

Resistance to soldering heat Max three 40 second reflows at +260°C, parts cooled to room temperature between cycles

Moisture Sensitivity Level (MSL) 1 (unlimited floor life at <30°C / 85% relative humidity)

Packaging 250/13" reel; Plastic tape: 32.4 mm wide, 0.5 mm thick, 24 mm pocket spacing, 10.6 mm pocket depth

PCB washing Tested to MIL-STD-202 Method 215 plus an additional aqueous wash. See [Doc787_PCB_Washing.pdf](#).

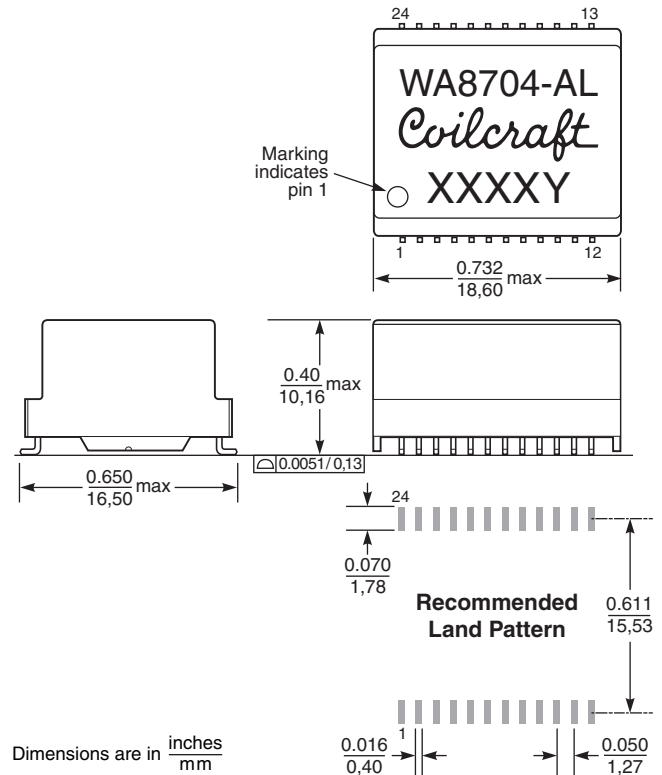
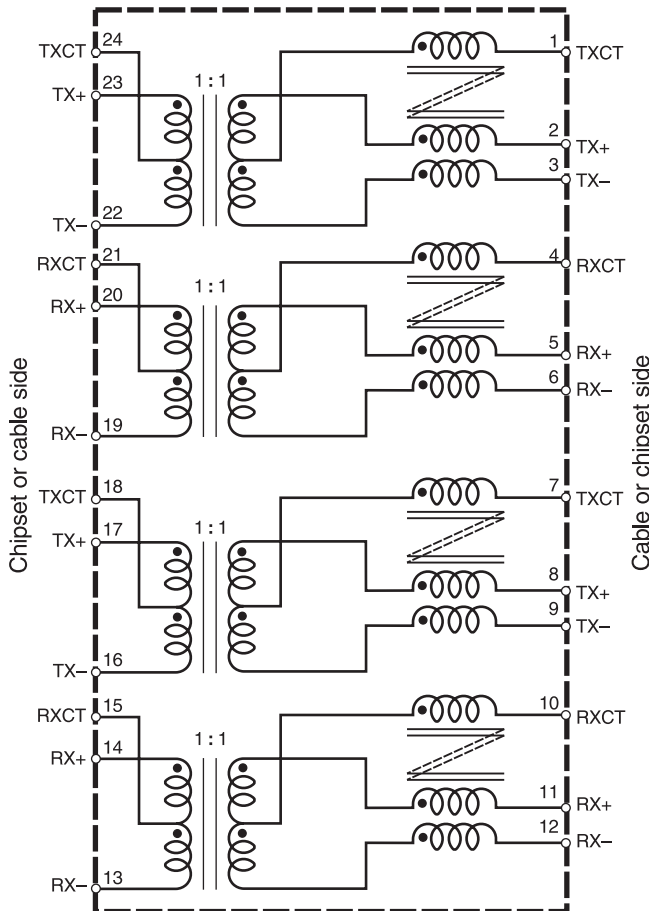

Dimensions are in $\frac{\text{inches}}{\text{mm}}$

*1.5 A DC current applied to each cable side center tap causes a 15°C rise from 25°C ambient. This is for reference only and does not represent absolute maximum ratings.



US +1-847-639-6400 sales@coilcraft.com
UK +44-1236-730595 sales@coilcraft-europe.com
Taiwan +886-2-2264 3646 sales@coilcraft.com.tw
China +86-21-6218 8074 sales@coilcraft.com.cn
Singapore + 65-6484 8412 sales@coilcraft.com.sg

Document 1503-1 Revised 07/10/23

© Coilcraft Inc. 2023

This product may not be used in medical or high risk applications without prior Coilcraft approval. Specification subject to change without notice. Please check web site for latest information.



“PoE Plus” Magnetics – WA8704-AL

Insertion Loss

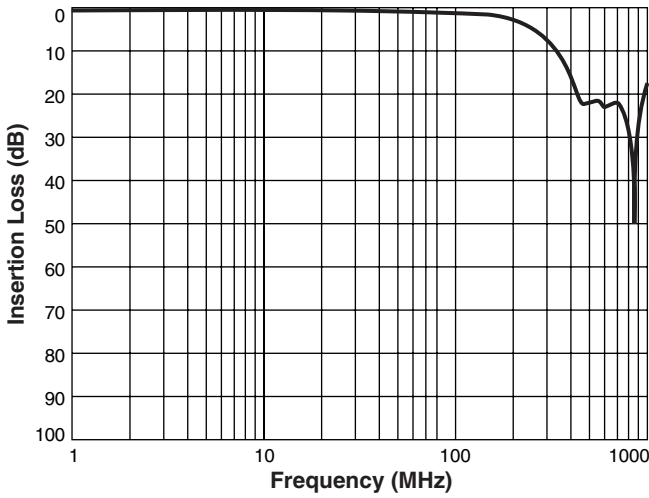

Return Loss

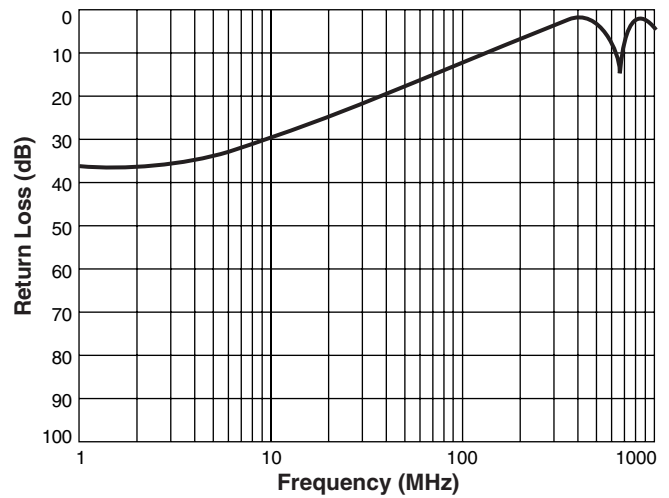

Differential to Common Mode Rejection

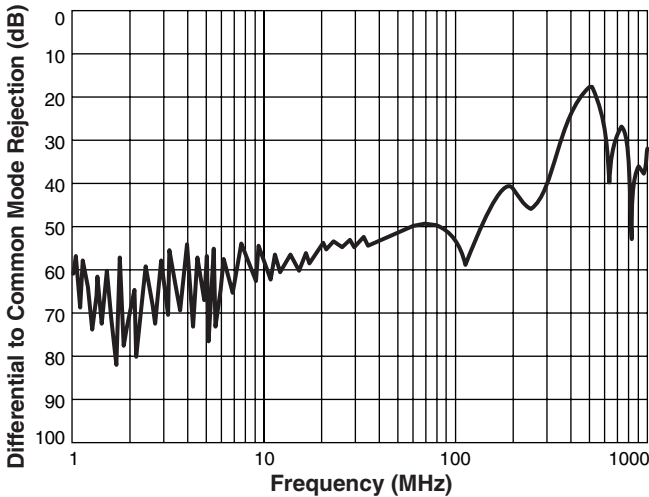

Crosstalk

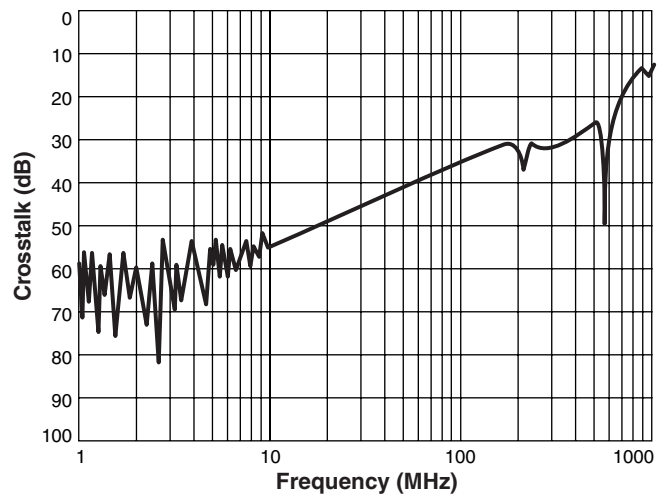

L vs Offset Current

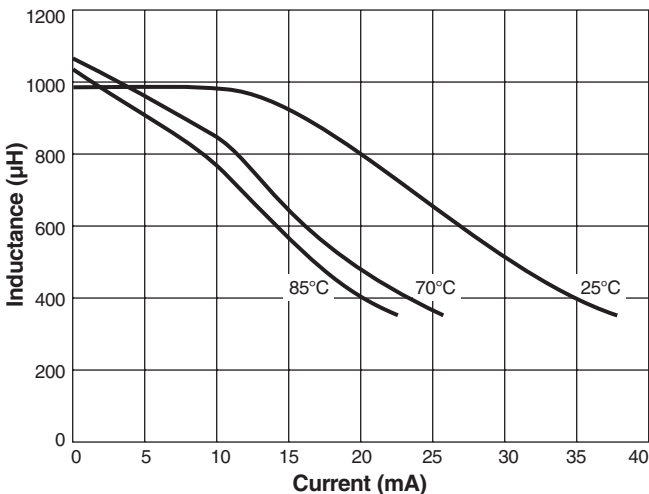

US +1-847-639-6400 sales@coilcraft.com
UK +44-1236-730595 sales@coilcraft-europe.com
Taiwan +886-2-2264 3646 sales@coilcraft.com.tw
China +86-21-6218 8074 sales@coilcraft.com.cn
Singapore + 65-6484 8412 sales@coilcraft.com.sg

Document 1503-2 Revised 07/10/23

© Coilcraft Inc. 2023

This product may not be used in medical or high risk applications without prior Coilcraft approval. Specification subject to change without notice. Please check web site for latest information.